

# Instruction Guide



## LED Light Source SL 3500

Please read the Guide before operating this product







**Manual Version: 2022/05**

© PSI (Photon Systems Instruments), spol. s r.o.

[www.psi.cz](http://www.psi.cz)

This document and its parts can be copied or provided to a third party only with the express permission of PSI.

The contents of this manual have been verified to correspond to the specifications of the device. However, deviations cannot be ruled out. Therefore, a complete correspondence between the manual and the real device cannot be guaranteed. The information in this manual is regularly checked, and corrections may be made in subsequent versions.

The visualizations shown in this manual are only illustrative.

This manual is an integral part of the purchase and delivery of equipment and its accessories and both Parties must abide by it.

## TABLE OF CONTENTS

<b>1</b>	<b>Warnings and Safety Precautions</b> .....	<b>6</b>
<b>2</b>	<b>General Description</b> .....	<b>7</b>
2.1	Standard Versions .....	7
2.1.1	Version SL 3500-A .....	7
2.1.2	Version SL 3500-B .....	7
2.1.3	Version SL 3500-C .....	7
2.1.4	Version SL 3500-D .....	8
2.1.5	Version SL 3500-E .....	8
2.2	List of Standard Components.....	8
2.3	Optional Accessories.....	8
2.3.1	Light Studio 485 SW with Light Controller LC 500 .....	8
2.3.2	Light Controller LC 100 .....	9
2.3.3	User-Defined Custom Protocol .....	9
2.3.4	Daylight Protocol .....	9
2.3.5	Modular Stand .....	10
2.3.6	Additional Protective Glasses .....	10
<b>3</b>	<b>Technical Specification</b> .....	<b>11</b>
<b>4</b>	<b>Device Installation</b> .....	<b>11</b>
<b>5</b>	<b>Device Operation</b> .....	<b>13</b>
<b>6</b>	<b>Manual Control</b> .....	<b>14</b>
<b>7</b>	<b>External Control</b> .....	<b>14</b>
<b>8</b>	<b>Warranty Conditions</b> .....	<b>15</b>

# 1 WARNINGS AND SAFETY PRECAUTIONS

**PLEASE READ THE FOLLOWING INSTRUCTIONS CAREFULLY BEFORE TURNING THE LED LIGHT SOURCE SL 3500 ON!**

## GENERAL ELECTRICAL SAFETY GUIDELINES:

- Perform a routine check of the devices and their wiring.
- Replace worn or damaged cords immediately.
- Use appropriate electrical extension cords/power bars and do not overload them.
- Place the devices on a flat and firm surface. Keep them away from wet floors and counters.
- Avoid touching the device, socket outlet or switch if your hands are wet.
- The LED Light Source should by always used with the original power supply (control unit) supplied by the manufacturer.
- Do not perform any alterations to the electrical part of the devices or their components.
- Never cover the power supply (control unit) or the light panel! Low ventilation can cause an irreversible damage to the device.

	<p>The LED Light Source SL 3500 is considered Class 1M* LED Product. LED radiation may be harmful to eye. Avoid direct and strongly reflected exposure. It is recommended to use protective glasses.</p> <p>*Class 1M: Laser and LED equipment that is safe under reasonable conditions of operation for use with the naked eye. Looking directly into the source of radiation by employing optics within the beam such as magnifying glass, telescope or microscope can be potentially hazardous.</p>
---	--



Fig. 1 Danger - LED radiation

## 2 GENERAL DESCRIPTION

The SL 3500 range of LED lights from Photon Systems Instruments are arrays of high-performance light emitting diodes that can operate under multiple regimes such as flash, continuous light and harmonically modulated light. They can also function work user-defined protocols. Different versions of the device are available with LEDs spanning the spectrum from blue to far-red.

The SL 3500 panels can be used as stand-alone units, or they can be integrated into cultivation areas and to provide lighting for growth rooms. The panels may also be integrated with other PSI instruments such as FluorCams, Photobioreactors or FytoScopes.

Basic control of the SL 3500 panels is by a supplied control unit. Enhanced output and modulation may be controlled by PSI's Light Controller LC 100, which provides precise regulation of light mode, intensity and timing. Optionally, PSI's Light Studio Software, allows computer control of the LED panels. User-defined protocols may be designed and implemented via both the Light Controller and the Light Studio Software.

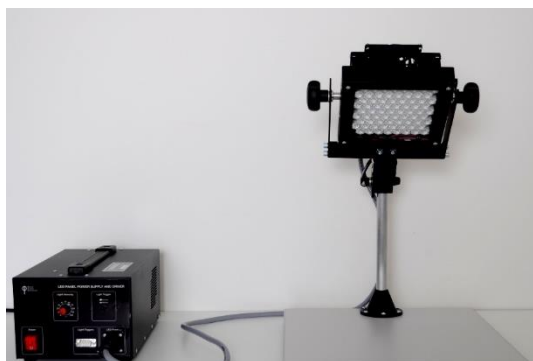

Fig. 2 Version SL 3500-A

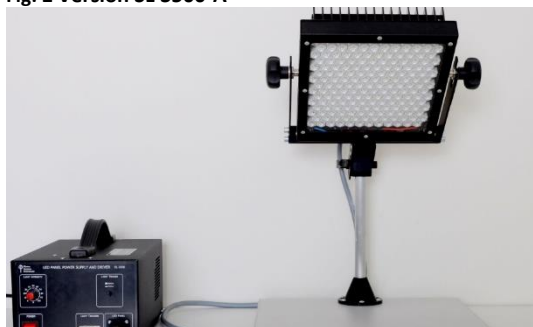

Fig. 3 Version SL 3500-B



Fig. 4 Version SL 3500-C

### 2.1 STANDARD VERSIONS

The panels are manufactured in number of versions differing in the panel size and illuminated area and in light color of the panel.

#### 2.1.1 VERSION SL 3500-A

- Panel size: 13 × 13 cm
- Single color: warm white or cool white or royal blue (440 – 460 nm) or red-orange (620 – 645 nm)
- Stand-alone operation: manual intensity control
- Supplied with a stand and holder

#### 2.1.2 VERSION SL 3500-B

- Panel size: 20 × 20 cm
- Single color: warm white or cool white or royal blue (440 – 460 nm) or Red (620 – 645 nm)
- Stand-alone operation: manual intensity control
- Supplied with a stand and holder

#### 2.1.3 VERSION SL 3500-C

- Panel size: 20 × 20 cm
- Four-color: Red (620 – 645 nm) – Green (520 - 540) nm – Blue (440 - 460) nm – FAR Red (720 - 750) nm
- Stand-alone operation: manual intensity control
- Supplied with a stand and holder



Fig. 5 Version SL 3500-D

#### 2.1.4 VERSION SL 3500-D

- Panel size: 30 × 20 cm
- Single color: warm white or cool white or royal blue (440 – 460 nm) or red-orange (620 – 645 nm)
- Stand-alone operation: manual intensity control
- Supplied with a stand and holder

#### 2.1.5 VERSION SL 3500-E

- Panel size: 30 × 20 cm
- 4 added Far red LEDs
- Four-color: color: Red (620 – 645 nm) – Green (520 - 540) nm – Blue (440 - 460) nm – FAR Red (720 - 750) nm
- Stand-alone operation: manual intensity control
- Supplied with a stand and holder



Fig. 6 Version SL 3500-E

## 2.2 LIST OF STANDARD COMPONENTS

Carefully unpack the carton, which contains:

- LED Light Panel with attached power and communication cable(s)
- power supply (control unit)
- detachable mains cable
- adjustable stand and holder
- instruction manual
- optional accessories (according to your specific order)

## 2.3 OPTIONAL ACCESSORIES

### 2.3.1 LIGHT STUDIO 485 SW WITH LIGHT CONTROLLER LC 500

Light Studio Software is a PC solution for precise control over the light mode, intensity and timing - (microseconds to hours). It supports light channel calibration and grouping. It can control unlimited number of logical light channels, formed from up to 254 physical light devices. Each logical channel can be configured independently. Light modulation is fully programmable, built from user-defined segments (continuous light and ramp). The software offers flexibility regarding the protocol composition and timing. There are just two predefined elements – constant element and ramp element. The protocol is then built from these two. A user can also add light channels to various groups and control them as one item/with one protocol.



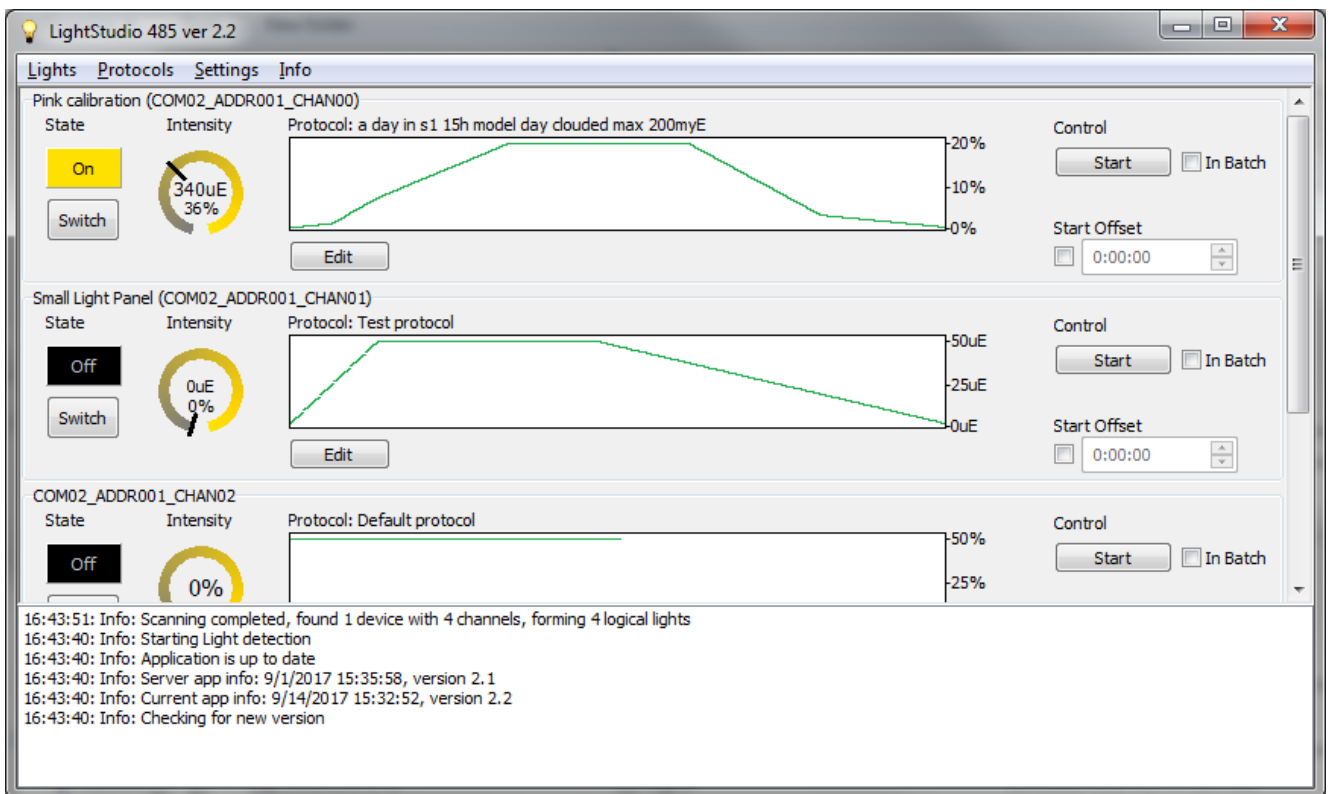

Fig. 7 Light Studio 485 SW

### 2.3.2 LIGHT CONTROLLER LC 100

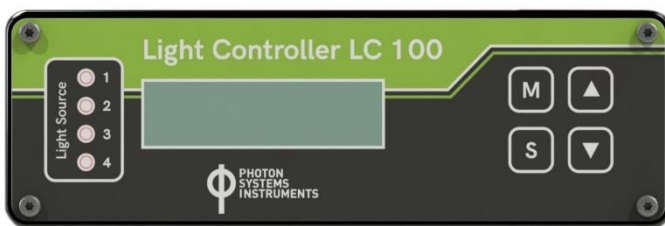

Fig. 8 Light Controller LC 100

LC 100 is a hardware, stand-alone solution for precise control of light characteristics and day/night simulation in SL 3500 LED Light Sources. It provides precise control over the light mode, intensity and timing (seconds to hours) and maintains also generation of short pulses (micro-seconds). It can control up to 4 lights/colors in SL 3500; each light/color can be configured and controlled independently. Light Controller LC 100 supports light modulation according to a predefined function (continuous, pulse, sine, triangle), user-programmed function (optional), or daylight simulation (optional). No PC is needed for this device operation.

### 2.3.3 USER-DEFINED CUSTOM PROTOCOL

Optional feature to the Light Controller LC 100: when uploaded to Light Controller, this Protocol can support up to 224 light phase intervals, each defined by light intensity and duration.

### 2.3.4 DAYLIGHT PROTOCOL

Optional feature to the Light Controller LC 100: when uploaded to Light Controller, the Daylight Protocol serves for cloudy skies simulations - several adjustable parameters. Includes also additional program for "cloud visualization" on a PC.

### 2.3.5 MODULAR STAND

Allows many spatial possibilities in arrangement and attachment of scientific instrumentation.

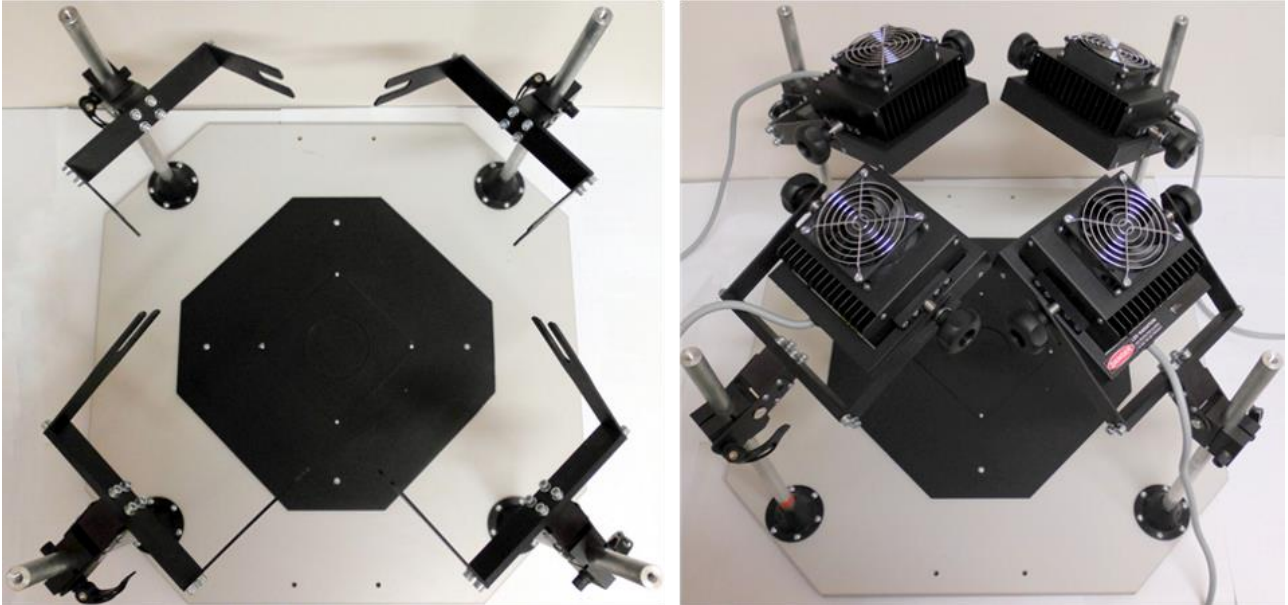

Fig. 9 Modular stand

### 2.3.6 ADDITIONAL PROTECTIVE GLASSES

Radiation safety glasses protecting against excessive LED radiation – equipped with side cover and protective filters. One pair of glasses is provided with the device free of charge.



Fig. 10 Protective Glasses

### 3 TECHNICAL SPECIFICATION

PPFD	Up to 3,000 $\mu\text{mol.m}^{-2}.\text{s}^{-1}$ at the distance of 20 cm
Panel External Dimension (W x D x H)	Model A: 17.5 x 17.5 x 11 cm (with holder screws: 17.5 x 28 x 11 cm) Model B and C: 25 x 22.5 x 11 cm (with holder screws: 25 x 33 x 11 cm) Model D and E: 23.5 x 34.5 x 11 cm (with holder screws: 23.5 x 45 x 11 cm)
Light Source	Light emitting diodes (LEDs): 455 nm, 530 nm, 617 nm, cool white (4,500 – 10,000 K) and others
Custom-Designed Protocols (optional)	Variable timing and scripts
Communication Port	I2C communication (used for Light Controller LC100 and Light Studio Controller)
Power Input	From 75 to 500 W (depends on the version and LED color)
Electrical	90 – 240 V

### 4 DEVICE INSTALLATION

#### IMPORTANT NOTE!

- First connect all device parts with cables.
- Then connect the device to an electrical power source and switch it on.

**Step 1: Mount the Light Panel onto the adjustable stand. (Fig. 11).**

- [1] Insert the rod into the fitting of the stand base.
- [2] Put a frame onto the rod and fix it using the clasp.
- [3] Insert the Light Panel into the frame and fix it on both sides using the knobs.

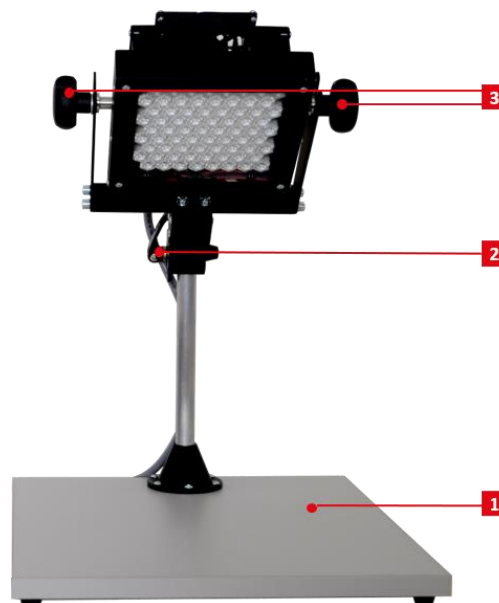

Fig. 11 Mount the Light Panel onto the adjustable stand



**Step 2: Connect the Light Panel to the Power Supply (control unit) (Fig. 12).**

- [1] Connect the Light Panel to the Power Supply (control unit) using the LED PANEL connector.
- [2] For the external control, connect the communication cable of the Light Controller LC 100 or of a PC to the Power Supply – use the LIGHT TRIGGER connector.

**Fig. 12 Connect the Light Panel to the Power Supply (control unit)**



**Step 3: Connect the mains cable to the Power Supply (control unit) (Fig. 13).**

- [1] Connect the mains cable to the connector on rear part of the Power Supply (control unit).

**Fig. 13 Connect the mains cable to the Power Supply (control unit).**



Fig. 14 Switch on the power switch of the Power Supply

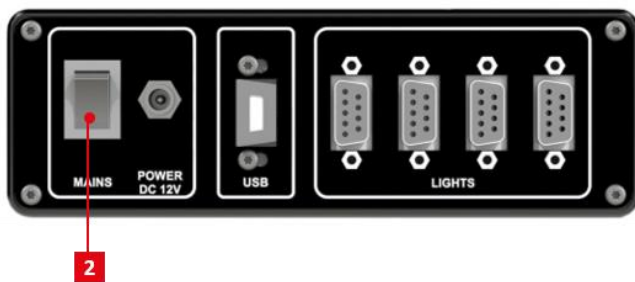

Fig. 15 Switch on the Light Controller LC 100

**Step 4: Connect the device to an electrical power source (110/230V). Be sure that the device and all peripheral units are switched off!**

**Step 5: Switch on the device.**

- [1] Switch on the power switch of the Power Supply control unit) (Fig. 14).
- [2] When using your LED Light Source with the Light Controller, first switch on the Power Supply. Then, switch on the Light Controller LC 100 (Fig. 15).

## 5 DEVICE OPERATION

The device can be controlled either in the manual mode or in the external mode:

- The manual control mode allows permanent lighting that can be controlled in the intensity.
- The external control mode provides the possibility of creating sophisticated protocols for precise control of the light mode, intensity and timing. Light can be dynamically modulated with periods ranging from microseconds to hours. The external control mode requires either the Light Controller LC 100 or the Light Studio software in a PC.

## 6 MANUAL CONTROL

- [1] The light intensity can be set on the front panel of the Power Supply (control unit) in the range of 0 – 100 %.
- [2] When using a multiple channel version of the device, each channel controls a different color. Each color's intensity can be controlled independently.

## 7 EXTERNAL CONTROL

- [3] Connect the Light Controller or the computer with the Light Studio software to the LIGHT TRIGGER connector of the Power Supply.
- [4] Enable the external light control by pushing the light trigger to REMOTE position.

More information on the external control mode is provided in the Operating Manuals of the Light Controller LC 100 or of the Light Studio software.

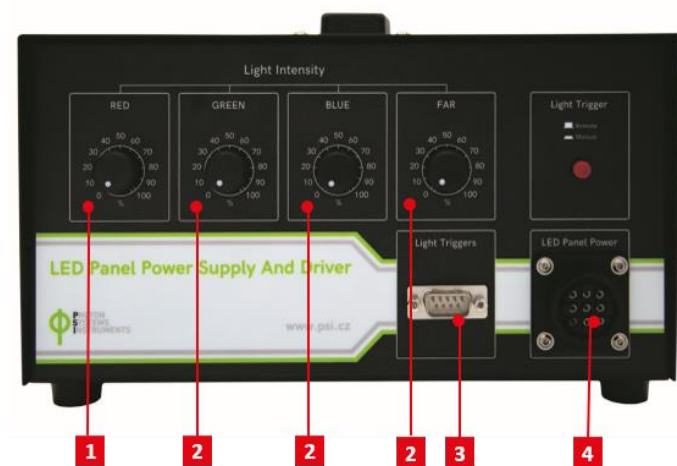

Fig. 16 Manual Control

## 8 WARRANTY CONDITIONS

1. Photon Systems Instruments, Ltd. (PSI) warrants all its instruments to be free from defects in materials or workmanship for a period of **one year** from the date of invoice/shipment from PSI. Warranty term for the European Union member states is **two years**.
2. If at any time within this warranty period the instrument does not function as warranted, return it and PSI will repair or replace it **at no charge**. The customer is responsible for shipping and insurance charges (for the full product value) to PSI. PSI is responsible for shipping and insurance on return of the instrument to the customer.
3. No warranty will apply to any instrument that has been (i) modified, altered, or repaired by persons unauthorized by PSI; (ii) subjected to misuse, negligence, or accident; (iii) connected, installed, adjusted, or used otherwise than in accordance with the instructions supplied by PSI.
4. The warranty is return-to-base only, and does not include on-site repair charges such as labor, travel, or other expenses associated with the repair or installation of replacement parts at the customer's site.
5. PSI repairs or replaces the faulty instruments as quickly as possible; maximum time is one month.
6. PSI will keep spare parts or their adequate substitutes for a period of at least five years.
7. Returned instruments must be packaged sufficiently so as not to assume any transit damage. If damage is caused due to insufficient packaging, the instrument will be treated as an out-of-warranty repair and charged as such.
8. PSI also offers out-of-warranty repairs. These are usually returned to the customer on a cash-on-delivery basis.
9. **Wear & Tear Items** are excluded from this warranty. The term **Wear & Tear** denotes the damage that naturally and inevitably occurs as a result of normal use or aging even when an item is used competently and with care and proper maintenance.
10. Some PSI instruments use accessories made by other manufacturers. In such case, these accessories may be covered by a different warranty period.
11. Contact us at [support@psi.cz](mailto:support@psi.cz) in case of any support with the assembly and installation of the device is needed.